

GPC/MS Analysis of Polymer Additives

Introduction

Polymers contain various additives for the additional functionality and stabilization of the product. Analysis of such additives is important for the quality control purposes in the polymer production. Those additives are typically analyzed by liquid chromatography and gas chromatography after pretreating the sample by extraction and concentration. The treatment steps are often complex and time consuming. On the other hand, by using the gel permeation chromatography (GPC), a polymer sample dissolved in an appropriate solvent can directly be analyzed. It separates the additives from polymers, and thus a simple and rapid detection can be expected.

Shodex Technical Article No. 8: "Ultra-Rapid Analysis of High Molecular Weight Compounds Using SEC Mode" summarized the ultra-rapid analysis of high molecular weight compounds using Shodex GPC HK-400 series columns, which are packed with uniformly controlled 3- or 3.5- μm styrene divinylbenzene copolymers. This article introduces the rapid, highly sensitive, and highly selective applications analyzing various polymer additives using HK-400 series columns with THF eluent and an MS detector.

Experimental

As a rapid GPC analysis column, we used Shodex GPC HK-401 (column size: 4.6 mm I.D. x 150 mm, particle size: 3 μm , exclusion limit (polystyrene): 2,000), a column suitable for the lower-molecular weight range analysis and Shodex GPC HK-404L (column size: 4.6 mm I.D. x 150 mm, particle size: 3.5 μm , exclusion limit measured with polystyrene: 1,000,000), a column suitable for a wide molecular weight range analysis.

The LC/PDA/MS system used was Shimadzu Nexera UHPLC system with LCMS 8030 Plus or Thermo UltiMate 3000 HPLC coupled to an Orbitrap Elite mass spectrometer with a flow switching valve system, set prior to the MS entrance. APCI was used as an MS ion source. Either SIM or Scan mode was used for the detection (Fig. 1). Figure 2 shows the structures of the samples studied, phenolic antioxidants, Irganox 1010 and Irganox 1076, and hindered amine light stabilizer (HALS), ADK STAB LA-68.

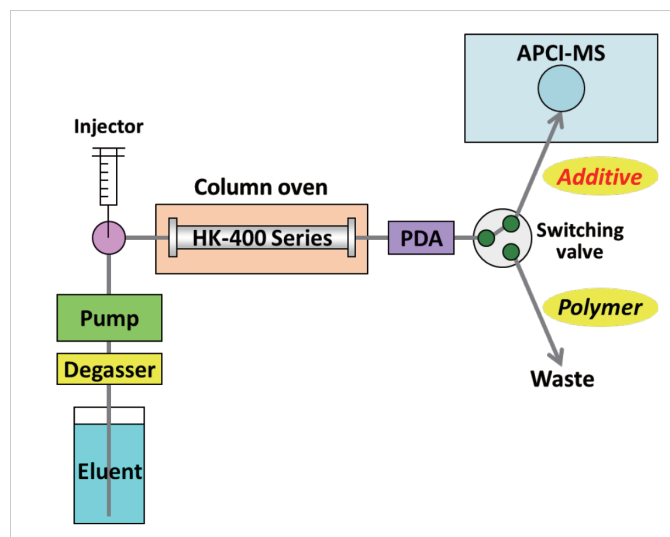

Fig. 1. Schematic diagram of the HPLC setting used.

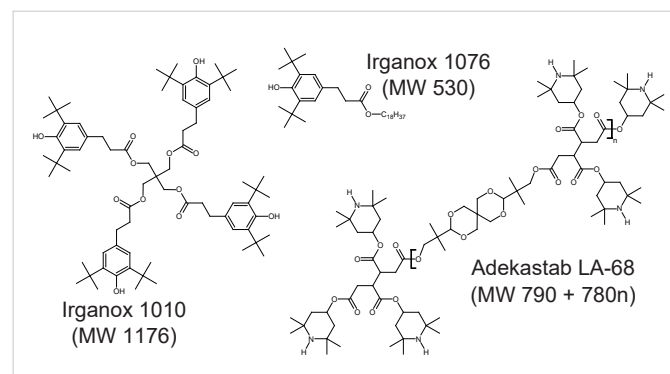

Fig. 2. Structures of additives studied

Results and Discussion

1. Optimization of HPLC conditions for the analysis of antioxidants

We analyzed a standard mixture containing antioxidants, Irganox 1010 and Irganox 1076, using HK-401 and GPC/PAD/MS. Figure 3 shows the chromatograms of 0.01- $\mu\text{g}/\text{mL}$ standard mixture. The antioxidants are not detectable by a UV; however, an MS can detect them as deprotonated molecular ions with high sensitivity and high selectivity. The analysis completes in 2 minutes, demonstrating an ultra-rapid analysis. The column pressure was about 13 MPa in this analysis. The particles packed in HK-401 are small (3 μm), but uniform. This uniformity prevents the pressure increase even when used at fast flow rates, which was not possible with existing products. Good linearities were obtained in the concentration range 0.01 to 1 $\mu\text{g}/\text{mL}$.

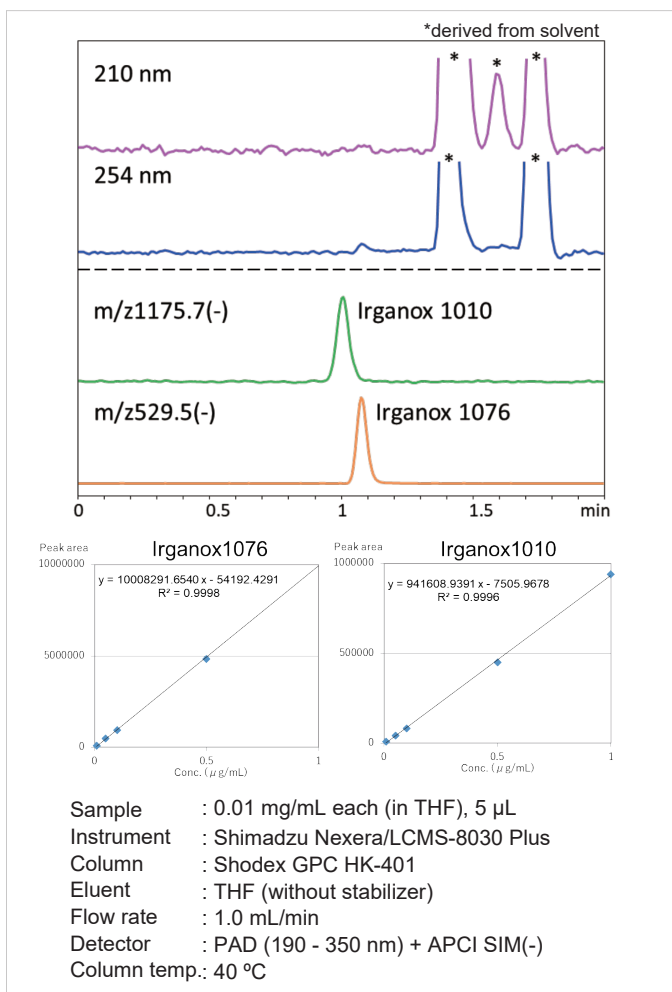

Fig. 3. Chromatograms of antioxidant standard mixture

The standard mixture was injected five times. Table 1 summarizes the coefficient of variation (CV) for the peak areas obtained from the analyses.

Table 1. Repeatability test result (peak areas of two antioxidants, n = 5)

n	Irganox 1010	Irganox 1076
1	8,473	81,451
2	8,707	79,786
3	8,835	81,738
4	8,489	81,145
5	7,992	80,232
CV (%)	3.4	0.9

2. Analysis of antioxidants in an instant noodle container

As an application of the developed method, we analyzed a commercial instant noodle styrene-foam container. The sample was dissolved in THF and injected directly to the GPC/PDA/MS system. Figure 4 shows the obtained chromatograms. The UV detected the elution of polystyrene near the exclusion limit (0.7 - 0.9 minutes), thus using the flow switching valve, we set the eluate after 0.9 minute to enter the MS. This prevents the risks of polystyrene from clogging the APCI probe or contaminating the ion source. Neither Irganox 1010 nor Irganox 1076 were detectable by the UV, but in this way, the MS detected them without the influence from polystyrene. Using the calibration curves shown in figure 3, Irganox 1010 and Irganox 1076 quantified were 0.16 and 0.23 mg/g, respectively. A ghost peak was observed at 0.9 minutes in the MS chromatogram. This is caused by the impact of flow switching, introducing THF to the MS.

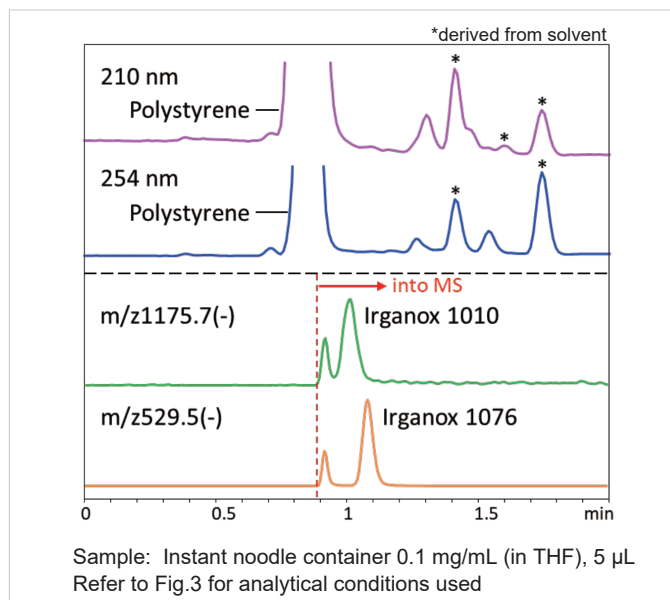

Fig. 4. GPC/PDA/MS analysis of an instant noodle container by HK-401

3. Analysis of antioxidants using multiple columns

Use of an HK-401 column alone can provide an acceptable analysis of antioxidants. However, depending on the molecular distribution of the target polymer, its separation from the added antioxidants may not be sufficient. In such cases, the column combination of HK-404L and HK-401 can provide improved separation. Figure 5 shows the chromatograms obtained from the GPC/PDA/MS analysis of an instant noodle container using HK-404L and HK-401 in series. Although the analysis time increased from 2 minutes (of using only HK-401) to 4 minutes, separation between Irganox 1010 and polystyrene was improved.

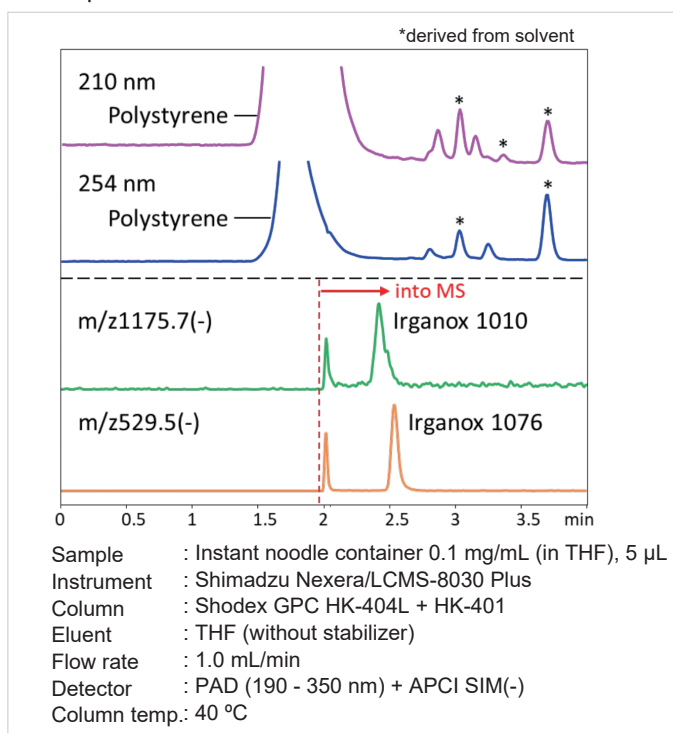

Fig. 5. GPC/PDA/MS analysis of an instant noodle container by HK-404L + HK-401

Figure 6 shows the chromatograms obtained from the GPC/PDA/MS analysis of polycarbonate resin dissolved in THF. By combining HK-404L and HK-401, Irganox 1010 was detected without the influence from polycarbonate. Irganox 1076 was not found in the sample, however presence of a phosphorus-based antioxidant, Irgafos 168 (MW 646) was observed. The results demonstrated the method's feasibility for the analysis of general polymer additives which dissolve in THF.

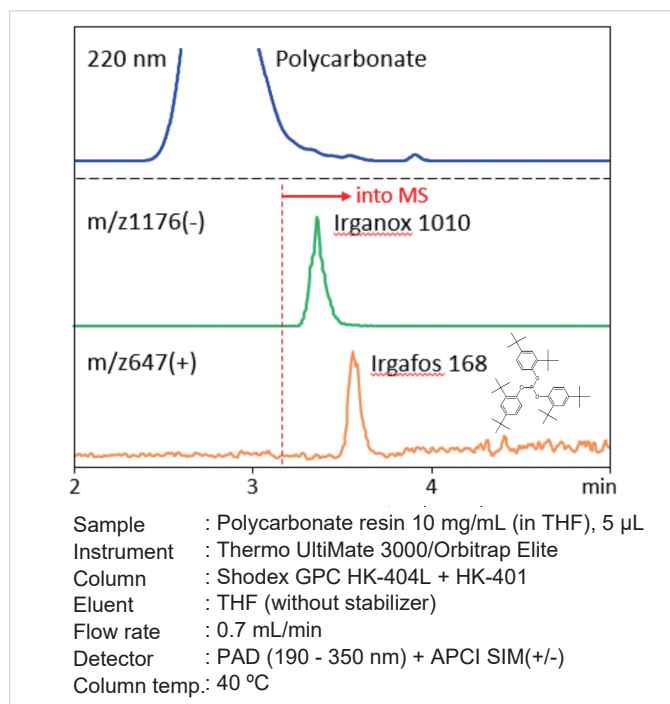

Fig. 6. GPC/PDA/MS analysis of polycarbonate resin

4. Analysis of hindered amine light stabilizer

Analysis of hindered amine light stabilizer (HALS), which contains an amino functional group, is known to be difficult. The presence of ionic interactions makes HALS to easily be adsorbed on the styrene divinylbenzene copolymer often used in GPC columns. Addition of ammonia in the eluent is expected to suppress the dissociation of the amino functional group in HALS, and subsequently to prevent its adsorption to the column. ADK STAB LA-68 standard solution was analyzed by GPC/MS method (Fig. 7). ADK STAB LA-68 is a HALS that contains several components of different molecular weights. The components with molecular weights 1570, 938, and 790 were eluted in the order of bigger to smaller molecular weights, and were detected as protonated molecules. Good peak shapes were observed for all components, showing the effectiveness of added ammonia. Also, good linearity was obtained for all components' calibration curves.

The MS system used for the analysis had the maximum measurement limit at molecular weight 2,000. However, the components with higher degree of polymerization (molecular weight larger than 2,350) should also be analyzed if an MS system with wider molecular weight measurement range was available.

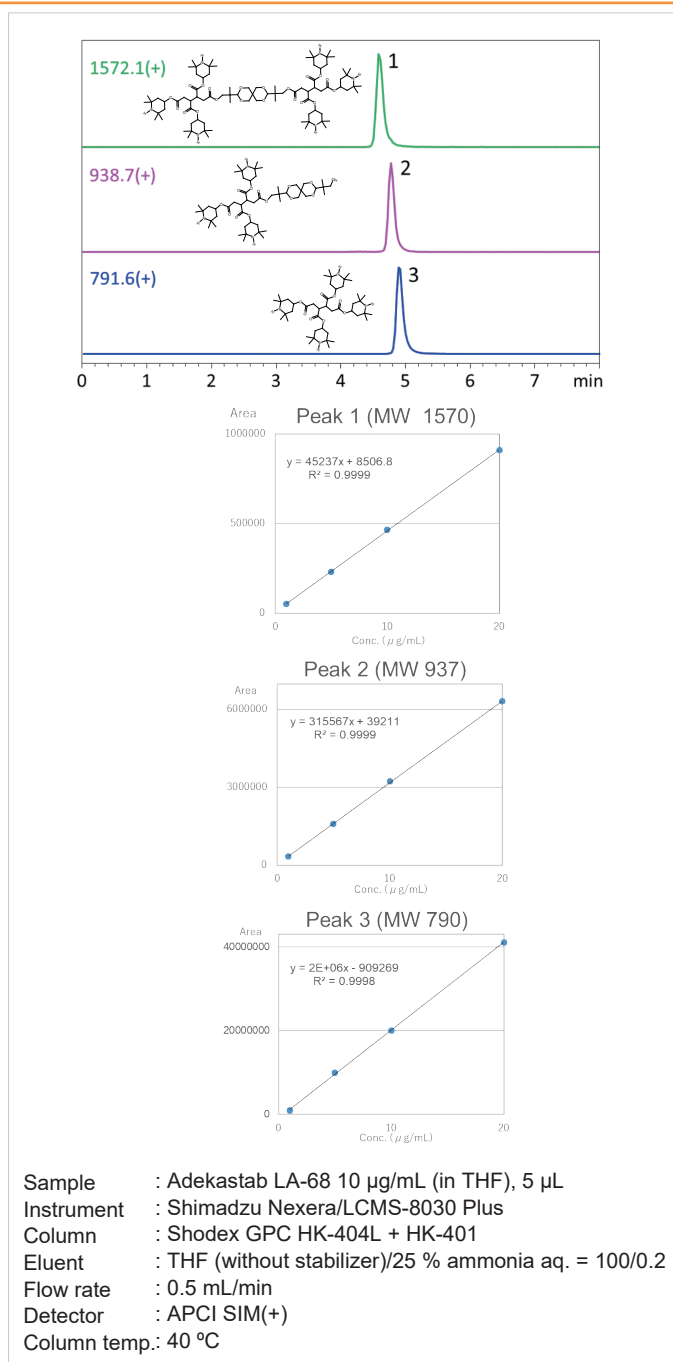

Fig. 7. GPC/MS analysis of ADK STAB LA-68 standard

Conclusions

The GPC/UV/MS method developed in this technical article allows the analysis of additives in polymers. The method does not require complex sample pretreatment, but simply to dissolve the sample in THF. The use of Shodex GPC HK-400 series column demonstrated a rapid analysis (2 minutes, the fastest). The method would be advantageous for the multi-sample analysis.

Because of the ionic interaction, highly basic additives such as HALS have a tendency of being adsorbed on the GPC gels. This makes them difficult to be analyzed. However, the HK-400 series columns packed with polymer base gels can avoid facing the problem by adding ammonia in the eluent and allows their quantifications.

<https://www.shodex.com/>

Resonac Corporation

Figures and descriptions in this article are provided to help you select appropriate columns. However they do not guarantee nor warrant the suitability for your applications.

TA, NO. 013. ① 20. D. JUN, P